

PRODUCT CATALOGUE

IZODOM 2000 POLSKA

Quick, simple and complete system for construction of passive buildings

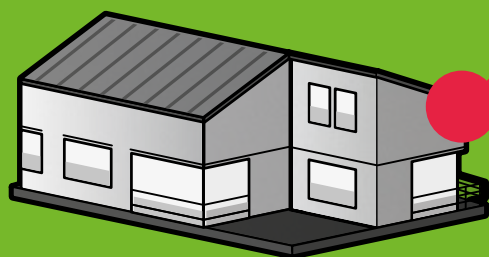

WALLS
WARMER BY 250%
THAN CONVENTIONAL
WALLS

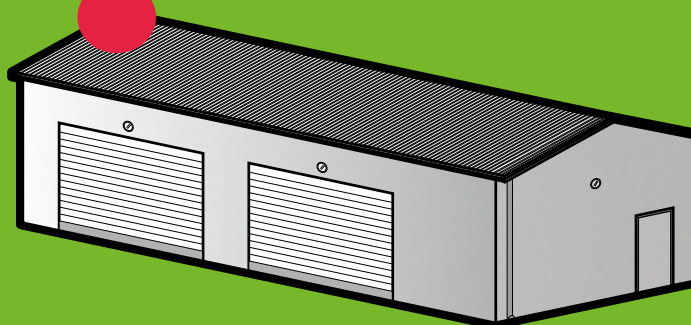

ROOF
WARMER BY 100%
THAN THE CONVENTIONAL
ROOF

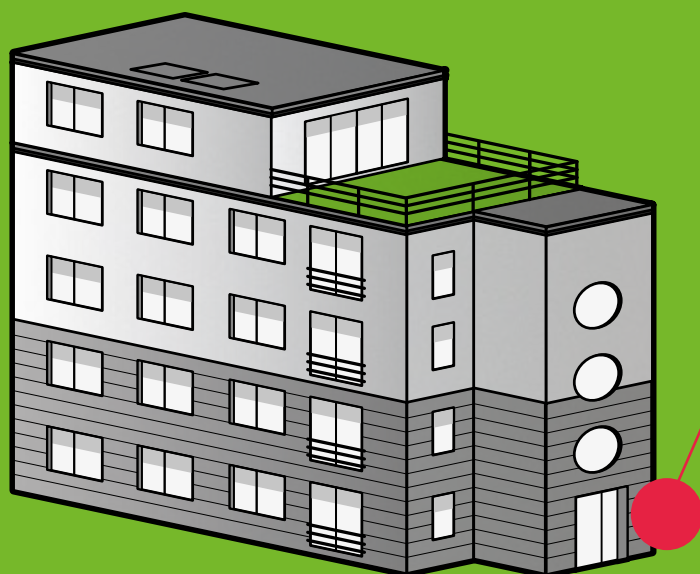

FOUNDATIONS
WARMER BY 400%
THAN CONVENTIONAL
FOUNDATIONS



CUSTOMER SERVICE
0048 – 43 – 823 – 41 – 88
0048 – 43 – 823 – 89 – 47



E-MAIL:
klient@izodom.pl



CALCULATE YOUR POTENTIAL SAVINGS
ON HOUSE CONSTRUCTION
www.pasywnedomy.eu



Izodom is a family company with 25 years of experience. It specialises in energy-efficient construction solutions. We export more than 90% of the manufactured products to Scandinavian and West European markets. So far, the Izodom technology has been used to construct 18,000 buildings worldwide.

FIND OUT MORE
www.izodom.pl



JOIN US ON FACEBOOK
www.facebook.com/izodompl



DOWNLOAD E-CATALOGUE
http://www.download.izodom.pl/product_catalogue.pdf



IZODOM 2000 Polska Sp. z o.o.
ul. Ceramiczna 2a, 98-220 Zduńska Wola
Customer service:
0048 – 43 – 823 – 41 – 88
0048 – 43 – 823 – 89 – 47
e-mail: klient@izodom.pl
Main office/fax:
0048 – 43 – 823 – 23 – 68
e-mail: biuro@izodom.pl
www.izodom.pl
www.pasywnedomy.eu

NIP: 726 000 04 14
REGON: 730192247
KRS: 0000225099

Share capital PLN 2,646,600 PLN

Are you an architect or design engineer?

Find out more about designing walls, ceilings, foundation and roof slabs according to the technology provided by Izodom. Request a set of Information Bulletins. architekt@izodom.pl

Are you a contractor with at least two years of experience?

Become a partner of Izodom! Come and take part in a free of charge training session. partnerstwo@izodom.pl



Izodom offers products developed in its own testing laboratory. Andrzej Wójcik, the company's founder, is the author of most solutions. Over 25 years of development, the product range has been increased from 8 to 200 patented products with restricted utility models and industrial designs.

Table of Contents

Completed projects	4
Construction based on the Izodom technology	5
Izodom System	6
Raw materials	10
The quality of Izodom	11
Technical Approvals	11
Awards and prizes	12
Support for the Polish economy	13

Izodom products	14
Elements for wall construction	14
Standard System	14
Prince Blok System	15
King Blok System	16
Super King Blok System	18
Blok Plus System	19
Universal System	19
Universal Plus System	20
Benefit System	20
Additional elements	21
Ceiling elements	22
Foundation slab	23
Roof insulation panels	23
Facade panels	24
Perimeter panels	24
Accessories	25

Construction process	26
How to place the Izodom foundation slab	27
How to construct the Izodom wall	31
How to place the Izodom floor slab	37
How to place the Izodom roof slab	39
How to place the Izodom facade panels	42
Izodom and its business partners	45
Additional services	46
Our completed residential housing projects	47

Completed projects in Europe



If you construct a building using the Izodom technology, you will...



save your time!

Construction of one medium-sized storey takes only 2 to 3 days, while construction of the entire house, beginning with the foundation and ending with the roof, will last no longer than a few weeks.

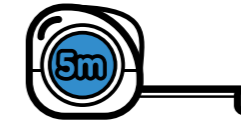

not waste any space!

The walls constructed according to the Izodom technology are thinner compared to traditional ones with the same thermal performance index. Therefore, even up to several metres of additional usable area, which is not obstructed by walls, can be obtained.

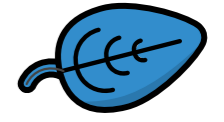

protect the environment!

An energy-saving house helps to avoid emissions of at least 18 tonnes of CO₂ a year! A low energy demand may be satisfied by means of solar generation, photovoltaic panels and other eco-sources of pure energy.



save your money!

You will pay bills that are 10 times lower! This amounts even to PLN 120,000 over 20 years! If your house has been constructed using Izodom elements, you will pay less for heating and air conditioning of your house. The foamed plastic used to manufacture element walls ensures pleasant cold in summer and efficient retention of heat in winter.

	House in the conventional technology	Energy-efficient Izodom house	Passive Izodom house
Construction cost	PLN 227,638	PLN 230,905	PLN 278,077
Heating cost over 25 years	PLN 152,913	PLN 99,559	PLN 44,145
Your savings	PLN 0 No savings	PLN 53,354 35% savings	PLN 108,768 72% savings

For a house occupying approx. 145 m²

Join the group of satisfied house owners.

The Izodom elements have been used to construct the royal palace of the King of Morocco and more than 18,000 other buildings worldwide, including 10,000 houses in Germany, the Netherlands, France, England, Poland and Scandinavian countries.



The Izodom system comprises more than 200 elements which can be put together like toy blocks to obtain the specified size and shape of your house.

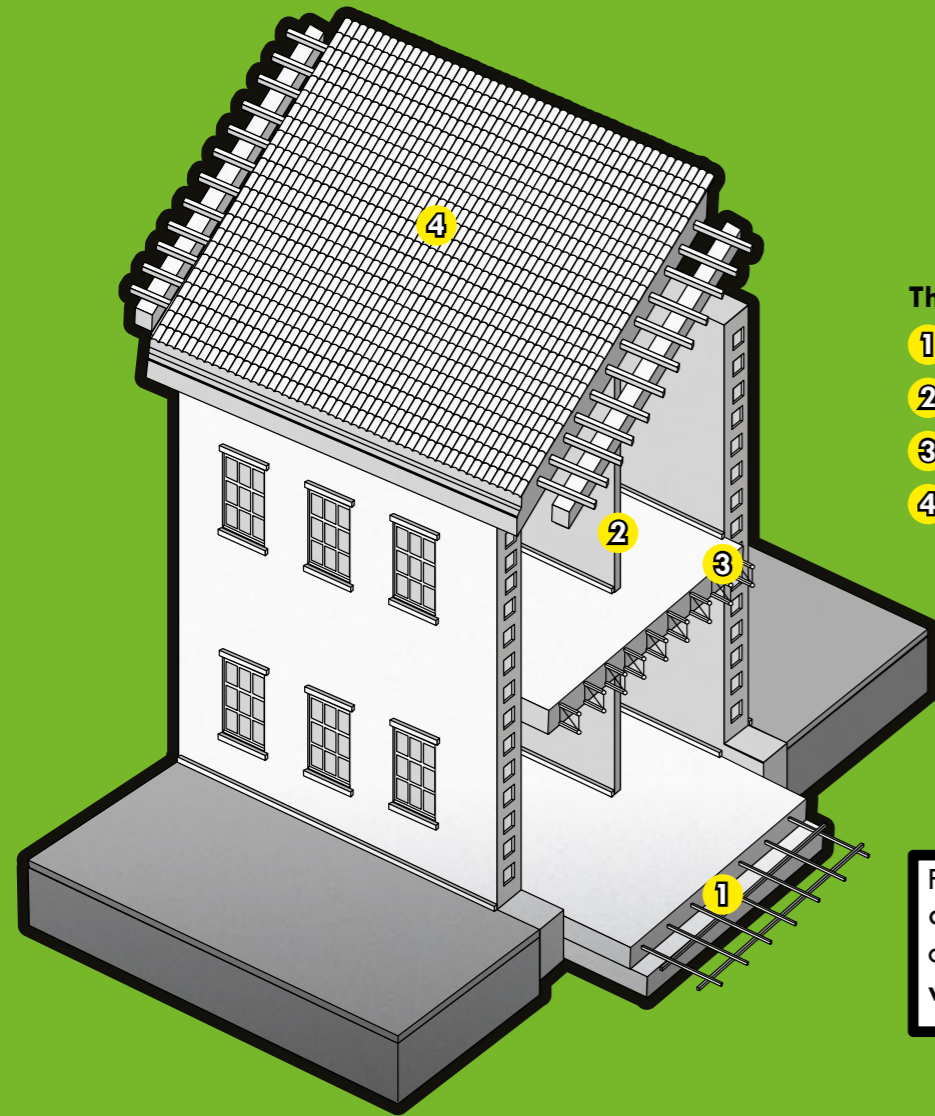

The system consists of

- 1 foundation slab
- 2 walls
- 3 ceiling
- 4 roof

Find out more about the full product offer. Request a product catalogue or visit the website www.izodom.pl/produkty

Construction

Elements used for the construction of walls, the ceiling and the foundation slab are filled with concrete. Roof slabs are placed on woodwork. Concrete grade and reinforcement (if any) are determined depending on the requirements specified in standards for individual structural components of the building.

The Izodom elements can be used to erect any type of structures, such as multi-storey residential buildings, single-family houses, schools, hospitals, hotels, churches, and even swimming pools.

The technology is safe and poses no hazard to health. Also, it is certified in the European Union and Poland.



Energy efficiency

All elements, i.e. walls, the foundation slab and the roof slab in a facility built according to the Izodom technology combine with one another to create a continuous layer of thermal insulation with perfect fit.

technologies. The thicker the insulation layer, the lower the cost incurred for building heating. Therefore, taking future-oriented approach, it is worth investing in good insulation.

Savings in the conditions present in Poland are estimated to amount to more than PLN 120,000 over 20 years.

This makes it possible to avoid thermal bridges, i.e. spots where cold and moisture may penetrate inside the house. Heat is encapsulated and accumulated inside the building. The main advantage of the technology is the obtained low energy consumption of the building; it can be higher even by 80%, compared to conventional

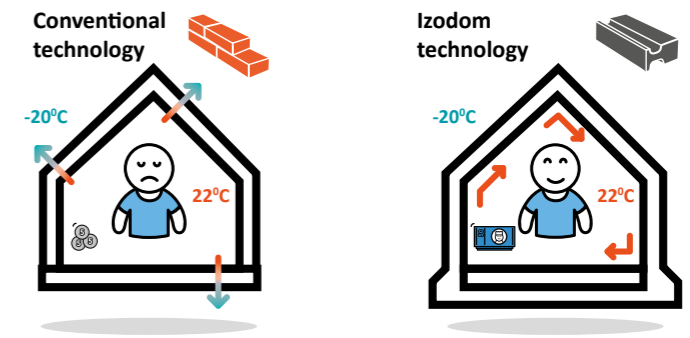

Various thicknesses of Izodom element walls make it possible to erect buildings rated under four energy efficiency classes.

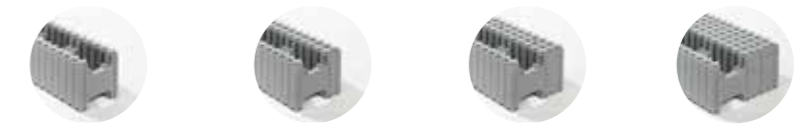

System	Standard	Prince Blok	King Blok	Super King Blok
Element type	MC 2/25	MC 2/30	MC 2/35	MC 2/45
Wall thickness <small>Int. insul. / concrete core / ext. insul.</small>	25 cm 5 / 15 / 5 cm	30 cm 5 / 15 / 10 cm	35 cm 5 / 15 / 15 cm	45 cm 5 / 15 / 25 cm
Wall cross section				
Heat-transfer coefficient (U)*	0.28 W/m ² K	0.22 W/m ² K	0.15 W/m ² K	0.10 W/m ² K
Building rating	energy-efficient industrial buildings	improved	energy-efficient	passive
Benefits	none	12% warmer than with current requirements	40% warmer than with current requirements	60% warmer than with current requirements

A lower heat-transfer coefficient U means better insulation.

* for standard U_c = 0.25 W/m²K of 1.01.2014 pursuant to Journal of Laws item 926 of 13.08.2013

Durable structure

The Izodom construction technology involves the so-called permanent formwork, which consists in building permanent concrete or reinforced concrete structures at the construction site.

The formwork elements are not removed, as is the case of conventional formwork. They are left in place to provide internal and external insulation of the constructed wall. Our company offers element sets with various thicknesses of the insulation layer as well as varied concrete core thicknesses. Durability of the

structure is estimated to exceed 150 years. With the right reinforcement, there can be constructed not only high buildings featuring several dozen or so storeys, but also structures in seismic zones or areas experiencing mine-related damage.

IZODOM Product catalogue

A building of any size

By selecting appropriate types of formwork elements, the type of concrete and reinforcement, the Izodom elements can be used to erect any type of building, such as multi-storey residential buildings, energy-efficient single-family houses, public access buildings, swimming pools, factory floors, utility buildings, cold stores, freezer rooms, etc.

Note that European regulations do not impose any height restriction or limitation on civil structures erected according to the Izodom technology.

While erecting very high buildings, the designer is only required to select a suitable type of concrete, reinforcement and elements with the core width sufficiently large to transfer all loads occurring in the structure being designed. The highest civil struc-

tures constructed using the Izodom technology include eleven-storey residential buildings.



Pace of construction

The Izodom elements are large and light. The basic "brick" has a surface area of 0.5 m² and weighs 1.8 to 4.8 kg before concreting (depending on the element width). While pouring the wall constructed with the Izodom materials with concrete, it is possible to finish 4.5 m² of wall (raw state) in an hour. Once cubic metre of concrete is sufficient to cast

concrete in 8 m² of wall. This solution is 6 times faster in comparison to traditional brick laying and installation on thermal insulation on walls. This quick pace of construction is not achievable when other energy-efficient technologies are employed. A reduced construction time means not only lower labour costs, but also lower cost of credit or flat rental.

In order to obtain the shell finish for a building whose architecture is not much complicated, a moderately trained construction teams need 4 to 6 weeks to complete the work.

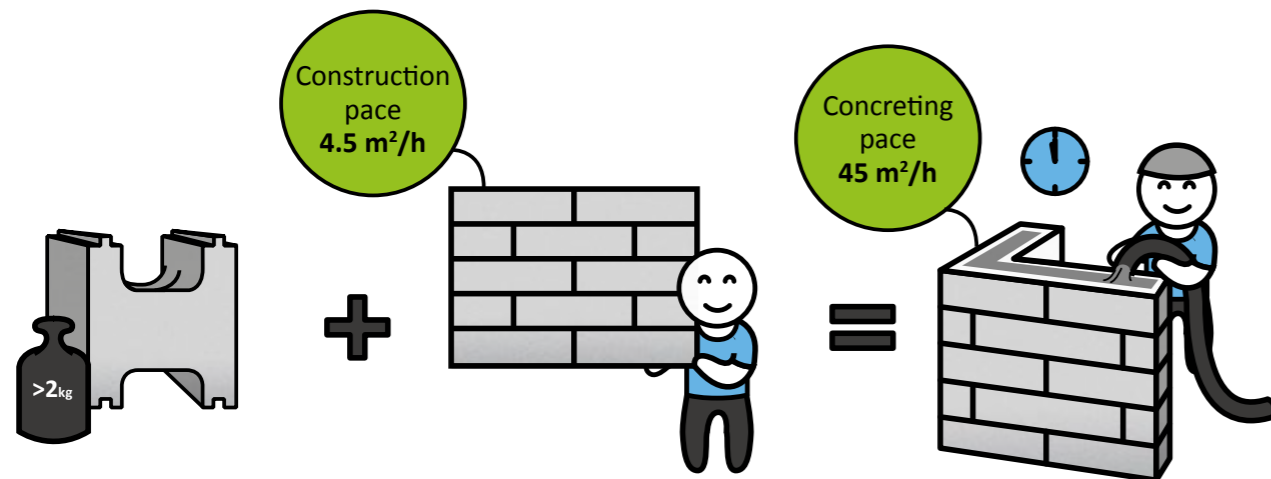

Additional area in a warm house

The walls made of the Izodom elements are relatively "narrow". Compared to a brick wall with the heat-transfer coefficient of $U=0.15\text{W/m}^2\text{K}$, the wall width would be 40-50 cm. A wall with the same level of insulation and

constructed according to the Izodom technology would be only 35 cm thick. The same thermal performance, but with a lower wall thickness, allows the developer to create approx.

5 m² of additional usable area while constructing a house with the floor area of 140 m². This aspect is particularly significant when it comes to selling the house.

Easy arrangement of systems

Systems are arranged within the wall core before concreting. Electrical cables may be arranged in the room, by placing them in grooves carved in the foam-type internal wall to be covered with the finish coating.

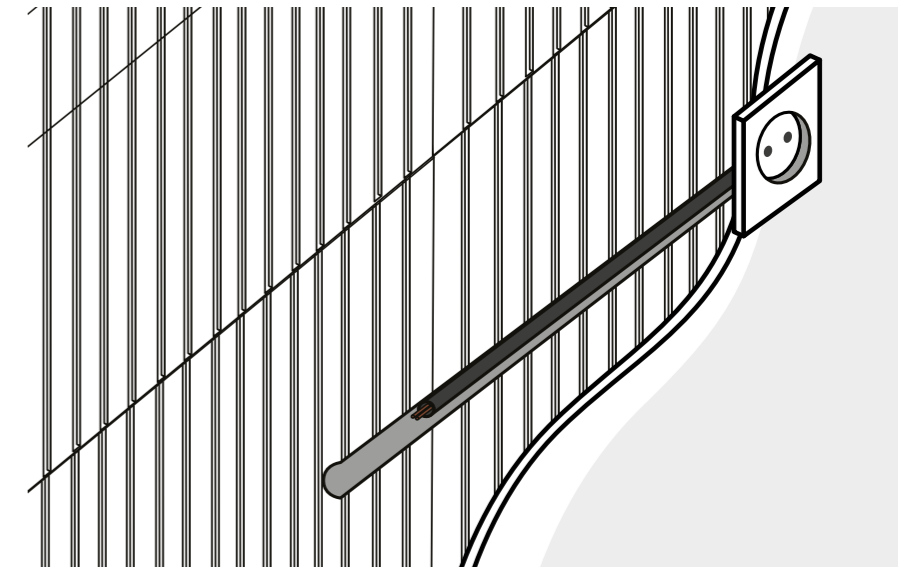

Finish work

For finishing internal walls, it is recommended to use gypsum boards or gypsum plaster with the thickness of at least 10 mm, applied mechanically using a generator unit. Finishing of external walls is usually made by applying thin-layer mesh plastering, facade with clinkers, ceramic tiles, facade panels, siding, etc.

For installation of cabinetry (e.g. kitchen cupboards) on the walls, it is required to apply suitably long expansion bolts screwed into the concrete core of the wall. One bolt with the length of 150 mm and diameter of 8 mm, anchored in concrete to the depth of only

100 mm, provides the load capacity greater than 150 kg. This means that a 500 kg boiler can be installed using only 4 bolts and a mounting bar.

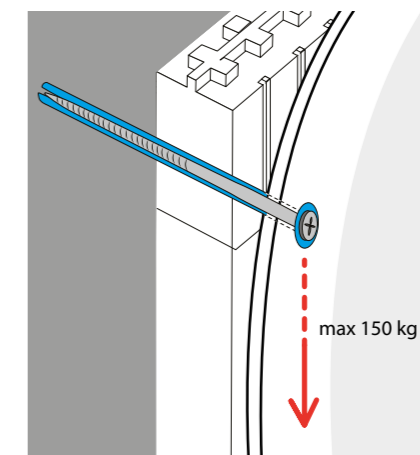

The Izodom system is suitable for construction in earthquake zones and areas subject to mine-related damage. While designing a civil structure to be constructed in this type of area, it must be reinforced accordingly by creating a type of cast-in-situ reinforced concrete box in which the foundation slab, walls and the ceiling are joined together and stiffened. For more information, please refer to Information Bulletins for Designers (see page 38).

Improved fire resistance

Izodom offers special elements with improved fire resistance, designated as REI 120. They comply with the strictest EU's standards so that facilities such as schools, including nursery schools, hospitals and hotels can be constructed.

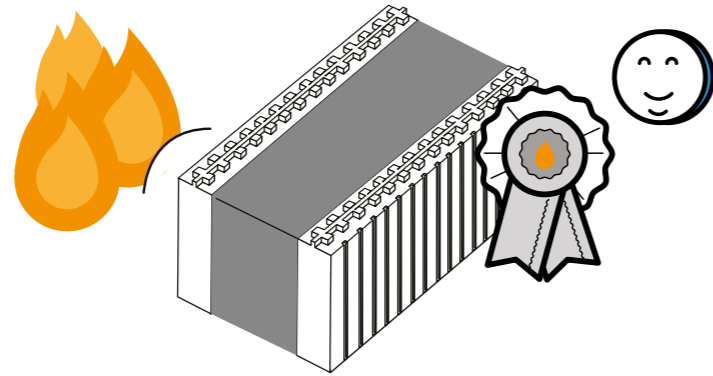

Positive environmental impact

Life Cycle Analysis studies how the product affects the manufacturing, operation and use environments. The results of such an analysis completed for two passive houses show that the house constructed according to the Izodom technology has an advantage over the brick house insulated with mineral wool.

The research conducted by Warsaw University of Technology, in accordance with ISO 14040, has shown a reduced emission of CO₂ by 56% and reduction of the accumulated energy by 11%. The technology has been appreciated by the Ministry of the Environment and the United Nations.

GREENEVO
AKCELERATOR ZIELONYCH TECHNOLOGII

Izodom is a winner in the competition for the best Polish green technology.

Izodom has been using for years the best raw materials supplied by the leading chemical industry supplier – BASF.

Raw material

There are three types of ESPs used to manufacture foam elements; all of which are manufactured by the chemical industry company – BASF.

The first one relates to expanded polystyrene, aka Styrofoam in Poland. The second type of raw material, which is grey ESP – Neopor, features better insulating properties. The third type – Peripor – is characterised by its material with minimum water absorbability and high resistance to external forces. Polystyrene is also used to ma-

nufacture food trays, added as the aerating agent in soil for cultivating gentle orchids as well as insulation in beehives.

Neopor – grey expanded polystyrene – with the additive of graphite and the property of retention of heat escaping by thermal radiation provides better insulating properties, compared to white ESP with the same density. Therefore, the insulation made of Neopor is thinner in comparison to typical expanded polystyrene.

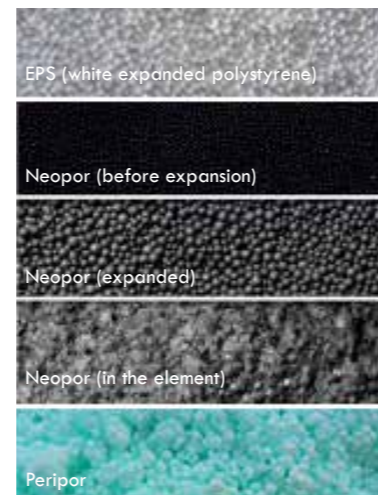

Since the establishment, Izodom has been taking care about provision of the highest quality of the offered products and healthy climate.

Safety, health and hygiene

The National Institute of Public Health, Municipal Hygiene Division, has granted Approval No. H/KB/1495/01/2007 to certify that "shaped units available in the Izodom construction system, containing polystyrene and additives, are approved for use inside and outside buildings". An additional confirmation of safety while using our raw materials is

the fact that we supplied polystyrene to the Polish Mother's Memorial Hospital in Lodz for years as fillers in pressure relief mattresses to prevent bedsores for premature babies. This fact has been confirmed by numerous gratitude letters to be seen on the walls in our office.

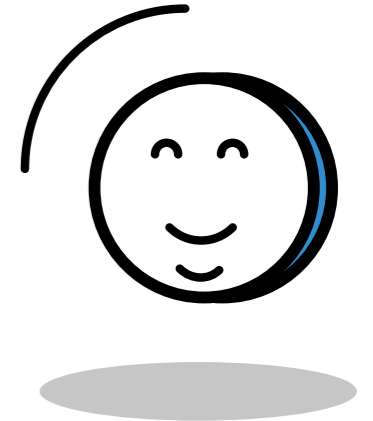

Technical Approvals

The Izodom products hold a CE-marking. In addition, pursuant to the Council Decision 93/465/ECC, the products have been granted a marketing authorization and are approved for trade throughout the European Union. Since 2007, our wall products have been granted prestigious European Technical Approval No. ETA-07/0117, issued by the German Institute for Building Technology (DIBt Deutsches Institut für Bautechnik).

The Building Research Institute in Poland supervises quality control in our manufacturing plant, issuing the Certificate of Factory Production Control No. 1488-CPR-0412Z. This certificate confirms not only safety of use, but also compliance with the strictest European safety standards, fire and quality regulations with which the Izodom elements comply. Following the highest quality standards is one of the most important objectives for our company.

Technique d'Application Demande AC 2009179-16D, issued by the Institute of Building Technology in France (Centre Scientifique et Technique du Bâtiment) is a special additional approval for use on the French market. www.cstb.fr.

Since 1995, the company has run the implemented quality control system conforming to Standard ISO 9001:2008, with TÜV Rheinland (Certificate No. 0198 100 01425) as the supervising body. For quality research and development work, it is very helpful to have one's own laboratory in which testing, such as fire, strength and thermal tests, can be carried out. We also appreciate cooperation with Polish and German research institutes and universities.



International awards and more than 50 prizes for Izodom

Awards:

Our company is the first manufacturer of building materials awarded by the Ministry of the Environment under the GreenEvo project (www.greenevo.gov.pl) in terms of building energy-efficiency features and the positive environmental impact exerted by the buildings.

In 2013, the European Commission awarded Izodom under the EU-Gateway Programme. The initiative was aimed at identification of the best 40 European building products and their demonstration in Japan.

Izodom is a member of Caring for Climate initiative run under the United Nations Environmental Programme, UN Global Compact and the United Nations Framework Convention on Climate Change.

This elite initiative comprises only 350 companies worldwide, those which signed a commitment agreement to act to the benefit of atmosphere protection and counteracting climate changes.

The cooperation of Izodom with the UN also involved a speech on energy-efficiency aspects delivered by a representative of the company during the World Climate Summit 2013 as well as a publication in the Global Compact Yearbook 2014 on sustainable development, issued by the local office of the UN in Warsaw. www.caringforclimate.org.



Caring for Climate



Major prizes:

- **Gold Medal at BUDMA International Construction and Architecture Fair in 2015,**
- **Orły Budownictwa 2015 (Eagles of Polish Construction Industry 2015),**
- **Personality of Building Industry** for the creator of technology,
- **Company with Energy 2015** (Contest held by the Gazeta Bankowa magazine),
- **The Most Innovative Company in the Lodz province 2014,**
- **Exceptional Exporter of the Year 2014** awarded by the Association of Polish Exporters,

- **Gold Badge - for those who have rendered great service to civil engineering and the industry of building materials** – awarded by the Ministry of Spatial Development and Building,
- **The first prize in the Small-Sized Exporting Enterprise) category** awarded by the Ministry of Economy and the Foundation of Small and Medium-Sized Enterprises.
- **Teraz Polska (“Poland Now”) Emblem** obtained in 2013,
- **Three nominations to the Economic Award granted by the President of the Republic of Poland**

in the categories as follows: “Polish small enterprise”, “Exporter” and “Innovative Company”,

- **Reliable Partner Certificate** confirming reliability, honesty and timeliness in business,
- **Grand Prix Award** at 16th Gryf Construction Fair,
- **First prize – Złoty Kask (Gold Hat)** – awarded by the Polish Chamber of Building Industry and Commerce,
- **Third prize – Złoty Kask (Bronze Hat)** – awarded by the Polish Chamber of Building Industry and Commerce.

Izodom supports Polish economy every day

In September 2015, Izodom became entitled to use the “Polski Ślad” (Polish Footprint) symbol. The symbol indicates Polish companies contributing to the prosperity of our country. Here is a quotation by the organiser – Fundacja Kazimierza Wielkiego (The Casimir the Great Foundation):

“The symbol of Polish Footprint is a sign indicating what and when is worth spending your money on to make it return as new jobs, infrastructure and public services. The red and white foot designates companies which pay their taxes in Poland, create not only jobs, but most first of all, actively build the strength of the Polish economy and contribute to the common budget of the entire society. The Polish

Footprint symbol indicates companies which are worth choosing as they create the potential of Polish entrepreneurship while growing in strength and decisions to invest their profits are made by our fellow countrymen.” www.polskislad.pl



Passive housing construction

Since 2014, our company has been a member of the Günter Szlagowski Polish Institute of Passive Building and Renewable Energy; also, we have become the Passive Building Ambassador. www.pibp.pl

Izodom is one of 6 founder members of the Polish Chamber of Building Industry and Commerce associating leaders in the sector for 25 year now. www.piphb.pl



Izodom supports:

- Polish-Estonian MTU Pro Polonia Club attached to the Embassy of the Republic of Poland in Tallinn. www.poola.ee
- “Płazik” Students’ Tourism Association at Lodz University of Technology, in particular during the event of the Yapa Tourism Song Contest. www.yapa.art.pl
- Actions taken by Lodz Young Team of the Polish Association of Civil Engineering Engineers and Technicians, e.g. during the renovation of a kindergarten in Lodz.
- “ŻURAW” Student Academic Association attached to the Civil Engineering Faculty at Lodz University of Technology.

STANDARD SYSTEM

Available raw material:
EPS $U_0=0.29 \text{ W/m}^2\text{K}$
NEOPOR $U_0=0.28 \text{ W/m}^2\text{K}$

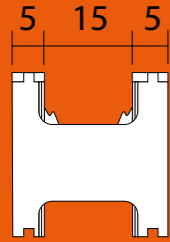

MC 1/25
Basic element
100x25x25 cm



MC 2/25
Basic element
200x25x25 cm



MC25 E45 RA/LI *
45° corner (right)
110(90)x25x25 cm
(external right / internal left)



ML25 E45 A/I *
45° header corner
95(75)x25x25 cm



MP25 E45 A*
45° ceiling support element
(external) 75x25x25 cm



MCF 1/25
Basic element with plastic tie
100x25x25 cm



MH 1/25
Height adapter
100x5x25 cm



MP25 E45 I *
45° ceiling support element
(internal) 75x25x25 cm



MH25 E45 A/I *
45° corner height adapter
95(75)x25x25 cm



MCB 1/25
Element for swimming pool
construction 100x25x25 cm



MCF 1/15
Partition wall element
100x25x15 cm



ML 1/25
Header block
100x25x25 cm



MP 1/25
Ceiling support element
100x25x25 cm



MCFU25 E90 LA/RI
90° corner
100(60)x25x25 cm
(external left / internal right)



MCFU25 E90 RA/LI
90° corner
100(60)x25x25 cm
(external right / internal left)



MH 1/15
Height adapter for
partition wall 100x5x15 cm



MCF 0,7/25
Hinge element with plastic tie
70x25x25 cm



MHF 0,7/25
Height adapter for hinge element
70x5x25 cm



MLA 1,2/25 *
Door header element
120x25x25 cm

PRINCE BLOK SYSTEM

Available raw material:
EPS or NEOPOR
EPS $U_0=0.23 \text{ W/m}^2\text{K}$
NEOPOR $U_0=0.22 \text{ W/m}^2\text{K}$



MC 2/30
Basic element
200x25x30 cm



ML 1/30
Header block
100x25x30 cm



MCF25 E45 LA/RI *
45° corner with plastic tie
85.4(64.6)x25x25 cm
(external left / internal right)



MCF25 E45 RA/LI *
45° corner with plastic tie
85.4(64.6)x25x25 cm
(external right / internal left)



MC25 E45 LA/RI *
45° corner (left)
110(90)x25x25 cm
(external left / internal right)

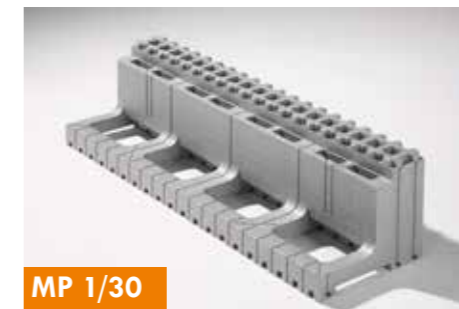

MP 1/30
Ceiling support element
100x25x30 cm

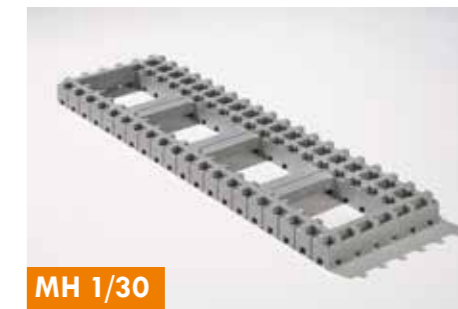

MH 1/30
Height adapter
100x5x30 cm



MCFU30 E90 LA
90° corner (external / left)
110x25x30 cm



MCFU30 E90 RA
90° corner (external / right)
110x25x30 cm



MCFU30 E90 LI
90° corner (internal / left)
40x25x30 cm



MCFU35 E45 RI *
45° corner (internal / right)
56.4x25x35 cm



MCFU35 E45 LI *
45° corner (internal / left)
56.4x25x35 cm



MH 35 E45 A *
45° height adapter (external)
93x25x35 cm



MCFU30 E90 RI
90° corner (internal / right)
40x25x30 cm



MLA 1,2/30 *
Door header element
120x25x30 cm

For more information on the installation, go to page 31



MH 35 E45 I *
45° height adapter (internal)
67x25x35 cm



MP 35 E45 A *
45° floor support element corner (external)
93x25x35 cm



MP 35 E45 I *
45° floor support element corner (internal)
67x25x35 cm

KING BLOK SYSTEM

Available raw material:
EPS or NEOPOR
EPS $U_0=0.16 \text{ W/m}^2\text{K}$
NEOPOR $U_0=0.15 \text{ W/m}^2\text{K}$



MC 1/35
Basic element
100x25x35 cm



MC 2/35
Basic element
200x25x35 cm



ML 35 E45 A *
45° header corner (external)
93x25x35 cm



ML 35 E45 I *
45° header corner (internal)
67x25x35 cm



MCFU35 E90 LA
90° corner (external / left)
120x25x35 cm



ML 1/35
Header block
100x25x35 cm



MP 1/35
Ceiling support element
100x25x35 cm



MCFU35 E90 RA
90° corner (external / right)
120x25x35 cm



MCFU35 E90 LI
90° corner (internal / left)
30x25x35 cm



MCFU35 E90 RI
90° corner (internal / right)
30x25x35 cm



MLA 1,2/35 *
Door header element
120x25x35 cm



MCFU35 E45 RA *
45° corner (external / right)
93.6x25x35 cm



MCFU35 E45 LA *
45° corner (external / left)
93.6x25x35 cm

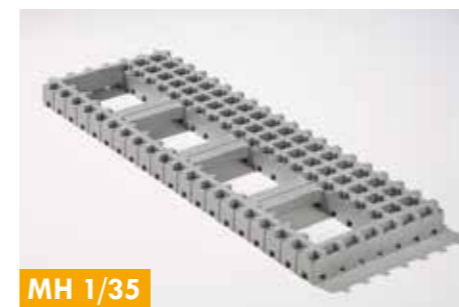

MH 1/35
Height adapter
100x5x35 cm

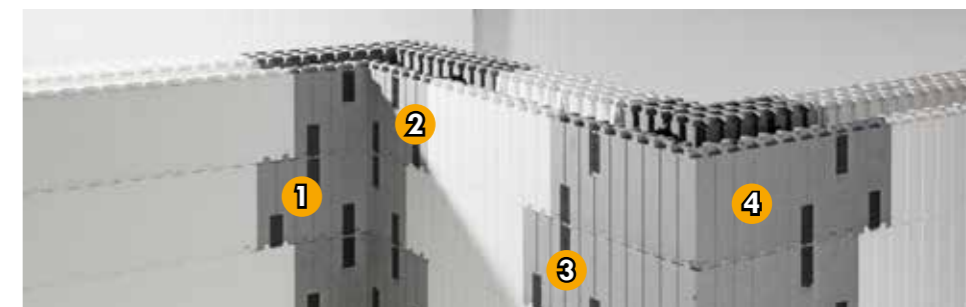

Schematic arrangement of corners (viewed from the inside of the building).
Applied elements: 1 MCFU35 E90 LA, 2 MCFU35 E90 RA, 3 MCFU35 E90 LI, 4 MCFU35 E90 RI.

SUPER KING BLOK SYSTEM

Available raw material:
EPS or NEOPOR
EPS $U_0=0.11 \text{ W/m}^2\text{K}$
NEOPOR $U_0=0.10 \text{ W/m}^2\text{K}$

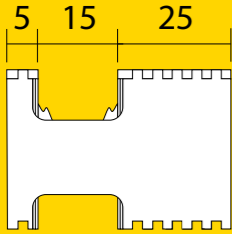

MC 1/45

Basic element
100x25x45 cm

ML 1/45

Header block
100x25x45 cm

MC 2/45

Basic element
200x25x45 cm

MP 1/45

Ceiling support element
100x25x45 cm

BLOK PLUS SYSTEM

Elements with 20 cm core
Available raw material:
EPS or NEOPOR
EPS $U_0=0.29-0.11 \text{ W/m}^2\text{K}$
NEOPOR $U_0=0.28 - 0.1 \text{ W/m}^2\text{K}$

! The system is available on special request only.

MCF 1/30+

Basic element
100x25x30 cm, core 20 cm

MCF30+ E45 LA/RI*

45° corner (left), core 20 cm

MCF 1/50+

Basic element
100x25x50 cm, core 20 cm

MCF30+ E45 RA/LI*

45° corner (right), core 20 cm

MLA 1,2/45 *

Door header element
120x25x45 cm

MCFU45 E90 LA

90° corner (external / left)
140x25x45 cm

MCFU45 E90 RA

90° corner (external / right)
140x25x45 cm

MCFU45 E90 LI

90° corner (internal / left)
35x25x45 cm

MCFU45 E90 RI

90° corner (internal / right)
35x25x45 cm

MH 1/45

Height adapter
100x5x45 cm

UNIVERSAL SYSTEM

Dismountable elements with 15 cm core
Available raw material:
EPS or NEOPOR
EPS $U_0=0.29-0.11 \text{ W/m}^2\text{K}$
NEOPOR $U_0=0.28 - 0.10 \text{ W/m}^2\text{K}$

MCFU 2/25

Element with plastic tie
200x25x25 cm, core 20 cm

MCFU 2/30

Element with plastic tie
200x25x30 cm, core 20 cm

MCFU 2/35

Element with plastic tie
200x25x35 cm, core 20 cm

MCFU 2/45

Element with plastic tie
200x25x45 cm, core 20 cm

MCFU 2/50

Element with plastic tie
200x25x50 cm, core 40 cm

CURVED ELEMENTS

Available on special request.
Curved elements are manufactured with any thickness and curvature.

For more information on the installation, go to page 31

MCFU 5

Single notched wall
200x25x5 cm

MCFU 10

Single notched wall
200x25x10 cm

MCFU 15

Single notched wall
200x25x15 cm

Perfect for the foundation footing

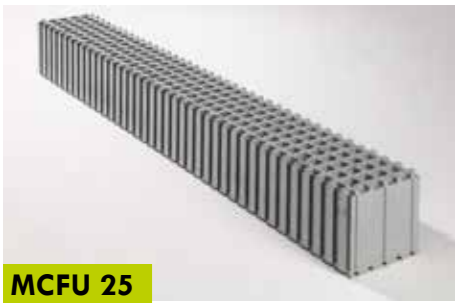

MCFU 25

Single notched wall
200x25x25 cm

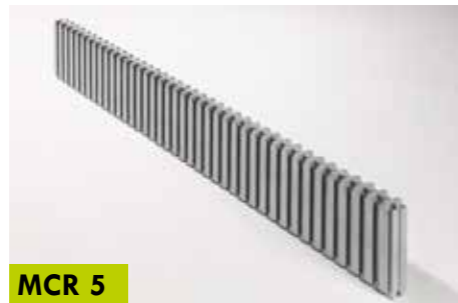

MCR 5

Single wall w/o notches
200x25x5 cm

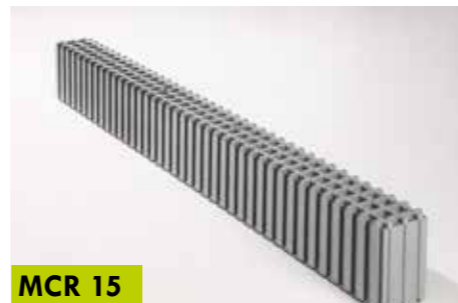

MCR 15

Single wall w/o notches
200x25x15 cm

ADDITIONAL ELEMENTS

Available raw material:
EPS or NEOPOR



OH

Top plug
15x10x5 cm



OB

Bottom plug
15x8x5 cm

UNIVERSAL PLUS SYSTEM

Dismountable elements
with 20 cm core

Available raw material:
EPS or NEOPOR



MCFU 2/30+

Hollow block with plastic tie
200x25x30 cm, core 20 cm



MCFU 2/35+

Hollow block with plastic tie
200x25x35 cm, core 20 cm



OC

Insert element
15x25x5 cm



OC BIS

Double insert element
15x25x10 cm



OC 0,2/1

Insert element, core 20 cm
20x25x5 cm



MCFU 2/40+

Hollow block with plastic tie
200x25x40 cm, core 20 cm



MCFU 2/50+

Hollow block with plastic tie
200x25x50 cm, core 20 cm



OC 0,2/2

Double insert element,
core 20 cm 20x25x10 cm



OC 0,4/2

Double insert element,
core 40 cm 40x25x10 cm



MD 1/10

Additional element
100x25x10 cm

For more
information on
the installation,
go to page 31

BENEFIT SYSTEM

13 cm thick elements
with 7 cm core

Available raw material:
EPS or NEOPOR



MC 1,1/13

Basic element
110x25x13 cm

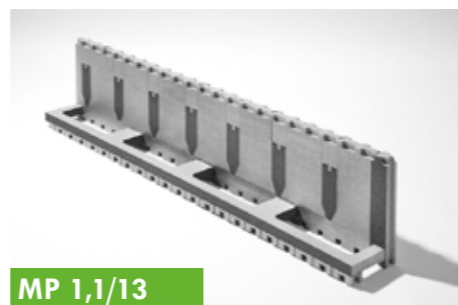

MP 1,1/13

Ceiling support element
110x25x13 cm



MHD 1/10

Height adapter MD 1/10
100x5x10 cm



LWG

Upper trimming strip
100x2.5x5 cm



LWD

Bottom trimming strip
100x2.5x5 cm



ML 1,1/13

Header block
110x25x13 cm



MLIP 15 = MRD 15

Bottom of the header element 15
200x8x15 cm



MLIP 20 = MRD 20

Bottom of the header element 20
200x8x20 cm



EC 90

90° corner reinforcing element
15x25x12 cm

FLOOR ELEMENTS

Available raw material:
EPS or NEOPOR
EPS $U_0=0.27-0.34 \text{ W/m}^2\text{K}$
NEOPOR $U_0=0.26-0.32 \text{ W/m}^2\text{K}$

The light and warm Izodom floors are built by placing pre-cast reinforcing beams between the rows of shape units, and 3 cm above the units there is a reinforcing bar mesh (5 or 6 mm thick, aperture 20 x 25 cm). This structure is poured with concrete up to 6 cm above the surface of the hollow blocks. This results in a reinforced concrete load-bearing rib-slab structure. Our company selects appropriate principal reinforcement of the ribs for the span and the number of insulating units. The typical maximum span can reach 7.8 m. Concrete consumption amounts to only 70-90 l/m² which depends on the span.

The solution is very light, even 3 times lighter in comparison with cast-in-situ concrete floors; the thermal insulation is also very good. It is perfect not only for newly constructed buildings, but also for modernisation of old buildings with low load capacity of the walls.

Standard loads transferred by the Izodom floors amount to 150 kg/m² (typical load in residential buildings). For floors subject to greater forces, it is recommended to have the design developed by a statics engineer.

The floors are designed appropriately to ensure conformity with wall elements. Also, they can be successfully used in buildings constructed according to other technologies.

For more information, please refer to Information Bulletin no. 3.



STP
Floor intermediate hollow block
75x20x25 cm



STK
Floor terminal hollow block
57x20x25 cm



STN
Floor cover element
100x5x60 cm



IZO/KJ
Truss
3.6 - 7.8 m



STP
Span: < 5.5 m, height: 25 cm
Concrete consumption: 70 l/m²



STP + STN
Span: 5.5 - 6.6 m, height: 30 cm
Concrete consumption: 80 l/m²



STP + 2 STN
Span: 6.6 - 7.8 m, height: 35 cm
Concrete consumption: 90 l/m²

For more information on the installation, go to page 27

FOUNDATION SLAB

Available raw material:
PERIPOR
 $U_0=0.14-0.09 \text{ W/m}^2\text{K}$

The foundation slab offered by Izodom can be successfully used instead of conventional foundation footing and walls. This is an on-site cast concrete slab with conventional bar reinforcement or fibre reinforcement.

For construction of the slab, basic formwork elements manufactured by Izodom are used. They make it possible to create various shapes of the slab, in accordance with the structure design. Concrete grade and reinforcement ratio are to be determined by the designer.

For more information on the installation, go to page 27

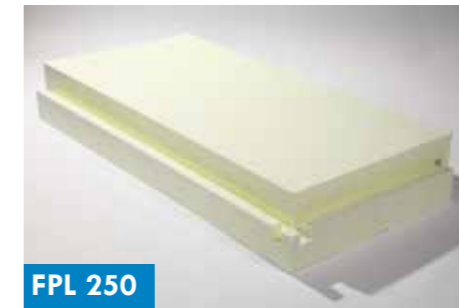

FPL 250
Foundation slab
190x25x90 cm



FPL BS†
Foundation slab kerb
200x50x55 cm



FPL EA
External corner for foundation slab
(80+80)x50x55 cm

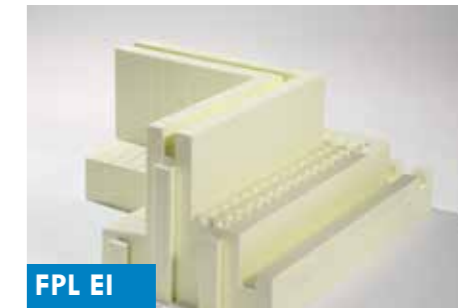

FPL EI
Internal corner for foundation slab
(40+40)x50x55 cm



FPL 120
Auxiliary foundation slab
195x12x95 cm; available with other thicknesses: 6, 8, 10 cm



FPL 250
Principle of joining foundation slabs

ROOF INSULATION PANELS

Available raw material:
EPS $U_0=0.15 \text{ W/m}^2\text{K}$

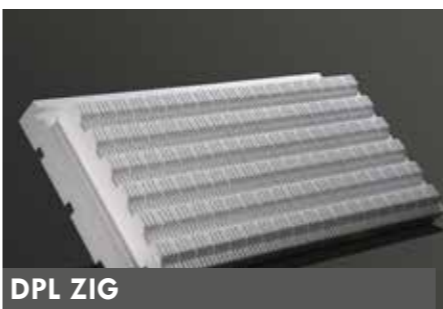

DPL ZIG
Above-rafter insulating panel placed under plain tiles,
190x25x90 cm

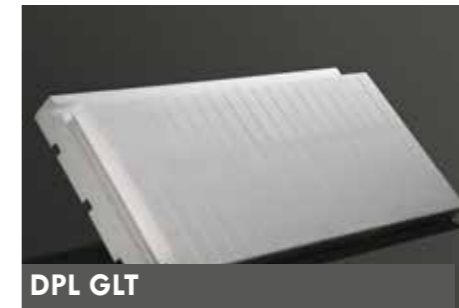

DPL GLT
Above-rafter insulating panel (plain)
190x22x90 cm

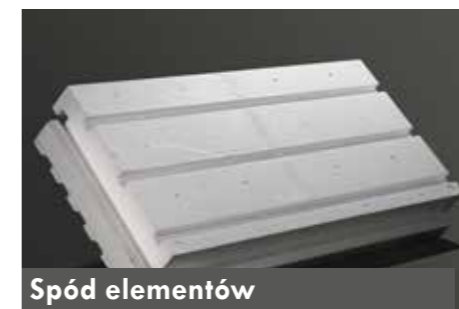

Spód elementów
Grooves facilitate installation on roof boards

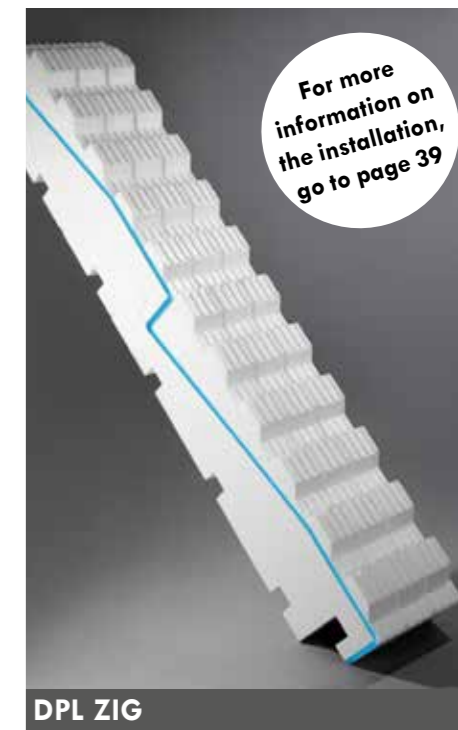

DPL ZIG
Special channels and hook locks facilitate drainage of water and condensate. The blue line indicates the escape path for moisture.

For more information on the installation, go to page 39

FACADE PANELS

IZOALFA / IZOBETA

Available raw material:
EPS or NEOPOR

The IZOBETA facade vented panel is a product for thermal renovation of existing buildings. With the use of the innovative solutions developed by Izodom, the application of the vented panels provides two effects: thermal insulation of the existing buildings and permanent drying of the insulated wall.

The IZOFALA panels offered by Izodom make it possible to complete permanent and tight thermal renovation of old buildings. The insulation panels with grout are suitable for easy finishing of the facade with 71 mm high clinker tiles.

For more information on the installation, go to page 42



Schematic principle of the IZOALFA panel



Installation of the IZOBETA panel

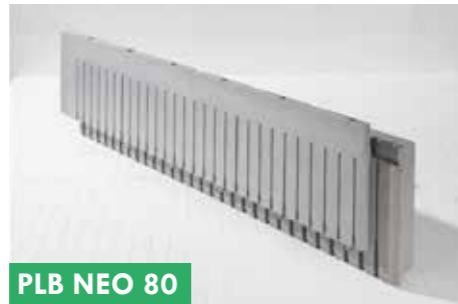

PLB NEO 80

Vented facade panel the so-called IZOBETA, 150x37.5x8 cm



PLB NEO 120

Vented facade panel the so-called IZOBETA, 150x37.5x12 cm



PL NEO 120 K

K panel ("IZOALFA"), 56.7x100x12 cm; also available with other thicknesses: 6, 8 and 10 cm



PL NEO 120 L

L panel ("IZOALFA"), 64.8x100x12 cm; also available with other thicknesses: 6, 8 i 10 cm



PER PL 30/60

Perimeter panel w/o geotextile, density 30 g/l, 195x95x6 cm; also available with other thicknesses: 8, 10, 12 cm



PER PL 40/60

Perimeter panel w/o geotextile, density 40 g/l, 195x95x6 cm; also available with other thicknesses: 8, 10, 12 cm



PER PL GEO 30/60

Perimeter panel with geotextile, density 30 g/l, 195x95x6 cm; also available with other thicknesses: 8, 10, 12 cm



PER PL GEO 40/60

Perimeter panel with geotextile, density 40 g/l, 195x95x6 cm; also available with other thicknesses: 8, 10, 12 cm

ACCESSORIES

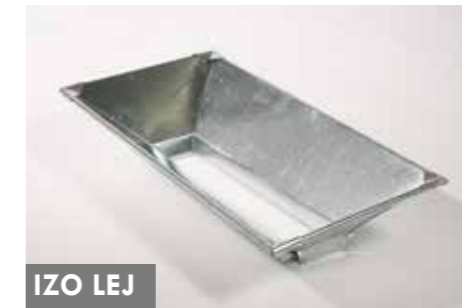

IZO LEJ

Concrete funnel



IZO LEJ

The funnel helps to protect element teeth from soiling.

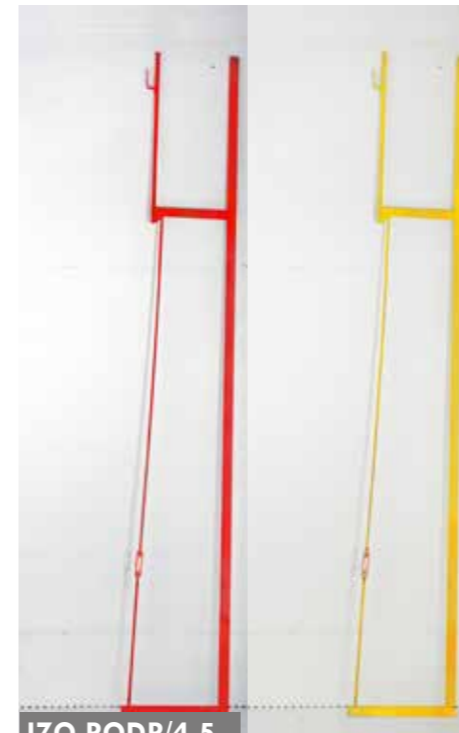

IZO PODP/4,5

Steel support (painted)
Height: 450 cm



IZO PODP/2,6

Steel support (painted)
Height: 260 cm

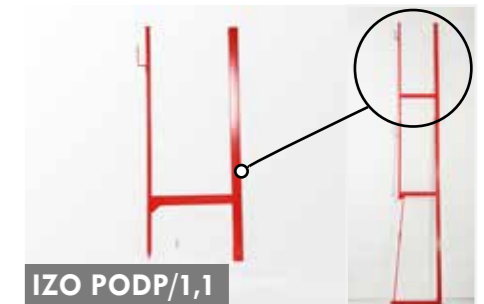

IZO PODP/1,1

Support extension (painted)
Height: 110 cm



IZO FISCHER

Screw for fixing supports



IZO OB

Steel clamp (painted) for fixing supports



IZO FID 50

ESP mounting screws



IZO FISCHER + IZO OB

Installation of the support in the wall



IZO BEL

Water vapour discharge tube

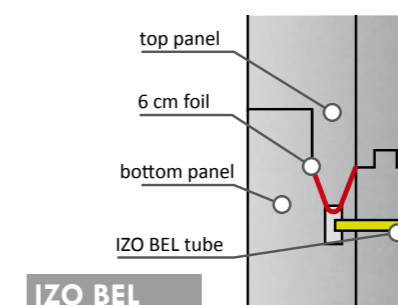

IZO BEL

IZO BEL tube installation in the IZOBETA panel

For 80 mm thick vented panels, there should be mini vent grilles with the length of 40 mm, and for 120 mm thick panels – 80 mm long grilles. The mini vent grilles should be glued in the prepared openings with the depth of 35 and 75 mm, respectively. For more information, go to page 44.

150 m² house in shell condition in 4 weeks.

Example constitution process acc. to the Izodom technology.

Feel free to contact Izodom for advice

Formal aspects:

- Purchasing land checked for suitability for construction (land development plan, soil type, depth of groundwater)
- Determining design assumptions from the investor's perspective (building size, roof type, house type, energy-efficient or passive, heat source type, habitable attic or no attic, etc.)
- Obtaining an extract of the local land development plan
- Purchasing an architectonic design from the Izodom House Design Catalogue or developing a custom design
- **Development of a building design, including:**
 - Land or plot development design
 - Architectonic and building design (you can request Izodom to provide a free of charge quotation of Izodom elements)
 - Soil test results
- Notification of planned commencement of construction of a single-family house submitted to competent authorities
- Submission of statement by the site manager "Notification of the construction work commencement date" to competent authorities
- Creation of the Construction Log

Construction:

- Carrying out foundation excavation
- Arranging systems under the foundation slab
- Construction of compacted bedding
- Arranging insulation under the foundation slab
- Reinforcing and concreting of the foundation slab
- Construction of an anti-freezing screen around the building
- Construction of external and internal walls and arranging systems at the same time
- Placing reinforcement and filling walls with concrete
- Placing elements of the floor, reinforcement and concreting
- Erecting subsequent floors
- Erecting the roof structure
- Arranging elements of the roof thermal insulation (including roof covering)
- Installing window and door joinery
- Distributing central heating, domestic hot water, electrical as well as water and sewage systems
- Applying internal and external plastering

Builder's finish:

- Indoor finish work: flooring, finish of bathrooms and sanitary fixtures, kitchen finish, finish of the attic/floor, installation of internal doors, painting work.

Turn-key completion

How to place the Izodom foundation slab

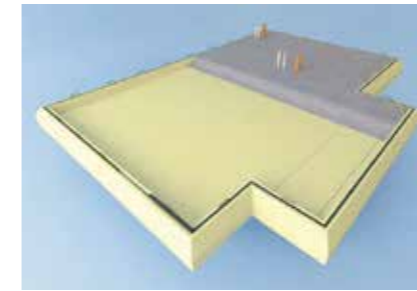

The foundation slab is one of the products offered by Izodom; it can be successfully used instead of traditional foundation footing and walls. This is an on-site cast concrete slab with fibre reinforcement or conventional reinforcing bars. For construction of the slab, basic formwork elements manufactured

by Izodom are used. They make it possible to create various shapes of the slab, in accordance with the structure design.

Concrete grade and reinforcement ratio are to be determined by the designer. The thickness of the reinforced concrete foundation slab is 25 cm. In exceptional cases when requested by the designer, the thickness may be increased up to 40 cm by applying special cover elements to increase height of the kerb element, and as such increasing thickness of the reinforced concrete slab. Insulation thick-

ness can be increased by another 6, 8, 10 or 12 cm when auxiliary foundation slabs are used.

In addition, the auxiliary slabs must protrude from the external outline of the foundation slab being constructed to approx. 1.5 m to prevent soil freezing under the slab type foundation.

Advantages of the Izodom foundation slab:

- 1 **Quick construction.**
With our elements, it is possible to reduce significantly the time required for foundation construction to 2-3 days!
- 2 **Stability.**
The foundation slab is cast-in-situ, which is much more stable compared with the foundation footing and walls currently designed.
- 3 **Easier thermal and moisture protection.**
Slab insulation is easier – there is no additional vertical or horizontal insulation necessary when constructing conventional foundation footing and walls.
- 4 **Easy construction.**
The design of the slab is exceptionally simple, so any errors during construction are avoided.
- 5 **Shallow slab installation.**
As it is possible to install the slab at a depth of only 0.5 m, the scope and time of earthwork can be reduced.
- 6 **Soil load capacity**
As the slab transfers smaller load to the soil, compared with the conventional foundation, there are more options of constructing the buildings on weaker soils.



Construction stages of the Izodom foundation slab

Construction of the foundation slab using formwork elements is a very simple process, which saves much time. Main construction stages are as follows:

Subbase preparation

Stripping of top soil and native soil to the depth specified in the documentation. Precise arrangement of the water and sewage system and other utility systems. While carrying out this work, great care must be taken to avoid alternation at a further stage of the already installed risers related to building internal systems. A filtration layer must be made on the stripped subsoil using coarse-grained aggregate or key aggregate. The material is to be laid in layers, wherein each layer is to be well compacted.

The recommended thickness of the filtration layer is 15 to 20 cm. Next, 3-4 cm thick sand bedding is made on the top of the filtration layer. Once the sand is levelled out and compacted, a damp-proof membrane consisting of two 0.3 mm thick film layers is made. The edges of the film are overlaid on the filtration layer edges to maximise protection of the slab from adverse impact of moisture. Also, only one base layer, approx. 15 cm thick and made of lean concrete, can be implemented instead of the filtration layer.

Perimeter drainage

If the level of groundwater is high, perimeter drainage must be constructed in the foundation excavation, possibly close to the lower edge of the filtration layer. The diameter of drainage pipes and the distance from the designed walls must comply with the documentation. The drained water must be discharged into the well, sewage system or the nearby watercourse.

Formwork installation

The insulating formwork elements are to be placed so that the required size and shape of the slab can be obtained. The slab shape must be made using the 5 cm module. Bottom elements must be joined with one another and with kerbs using hook bolt locks. The kerbs and corners are joined using dovetail joints. In order to obtain the required dimensions of the elements, they are cut with a wood saw or a special thermal guillotine cutter (also available in the Izodom offer).



The hook bolt lock provides a stable joint of the slabs.

Reinforcement

Reinforcement must be installed in accordance with the documentation. This should be fibre or traditional mesh reinforcement; also, a combination of these two solutions can be applied.

Concreting

The formwork is filled with concrete of the right grade and consistency. Always follow strictly the design and concrete manufacturer's recommendations. Gaps in the top part of corner elements are filled with shape units made of insulating plastic offered by Izodom.

The freshly cast concrete must always be protected from adverse impact of weather conditions.

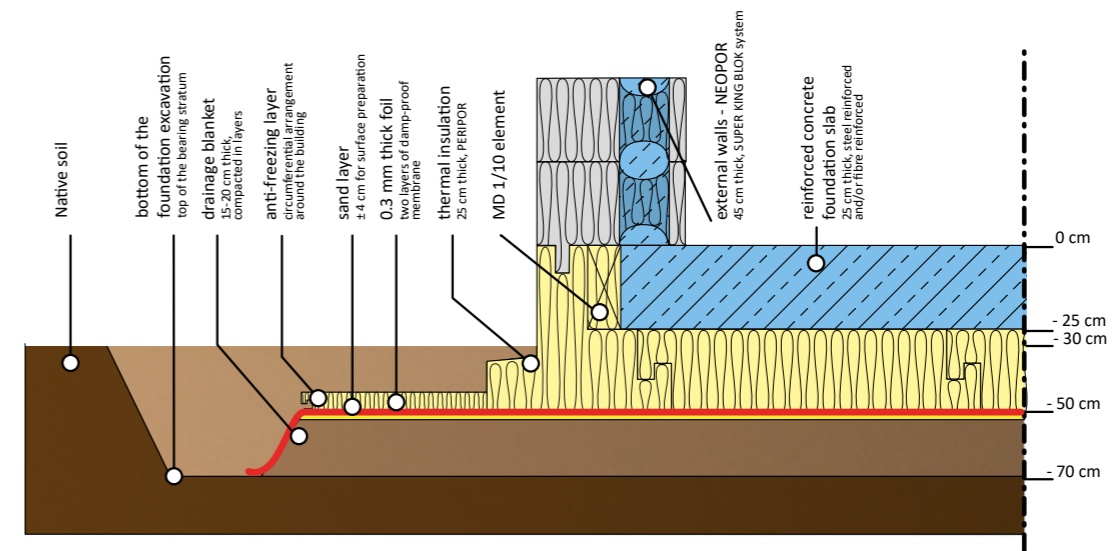

Fig. 1 Schematic construction of the slab foundation with 45 cm thick external walls (Super King Blok)

While constructing a passive house, suitably thick and warm walls made of Izodom's Super King Blok $U_0=0.10 \text{ W/m}^2 \text{ K}$ are used, and the foundation slab is fitted with additional insulation.

The heat-transfer coefficient for this kind of foundation may be as high as $0.09 \text{ W/m}^2 \text{ K}$, which makes it the warmest foundation in Europe. An additional MD element increases kerb thickness and facilitates installation of

a bridge-free joint between the slab and the wall. If the level of groundwater is high, an additional waterproof barrier given as plastic sheet used for construction purposes can be applied.

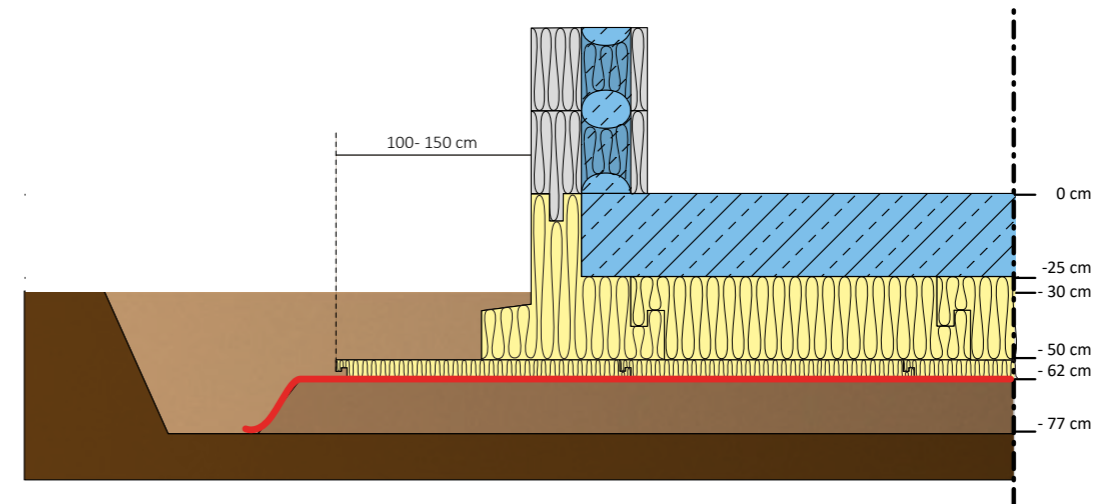

Fig. 2 Schematic construction of the slab foundation using additional thermal insulation.

Traditionally, to protect the building from bursting, foundation walls are constructed below the so-called "freezing depth", which is 1 to 1.4 m. This protects the structure being constructed from consequences of soil freezing. A less expensive solution consists in making the FPL insulation panel (6-12 cm) protrude from the building outline by 1-1.5 m.

As a result, the so-called freezing path is considerably extended. This measure protects the building even more effectively by avoiding deep and expensive excavation work.

While building an energy-efficient house, it is possible to use the Izodom King Blok elements ($U_0=0.15 \text{ W/m}^2 \text{ K}$) and the foundation slab.

A thick layer of insulation under the building is perfect for protection from frost entering beneath the building, freezing and bursting phenomena. This is the reason why foundation slabs are so popular in Scandinavian countries.

Essential characteristics for the intended application, for thermal insulation in the building industry	Declared performance, rating or level	Testing standard	Harmonised technical specification
Dimensional tolerance classes: thickness, length, width, squareness, flatness	T2 (± 2 mm) L3 (± 3 mm) W3 (± 3 mm) S5 (± 5 mm/1m) P10 (10 mm)	EN 823 EN 822 EN 822 EN 824 EN 825	PN-EN 13163:2013-05E
Bending strength level	BS 500 (≥500 kPa)	EN 12089	
Dimensional stability class under constant normal laboratory conditions	DS(N)5 - (±0.5 %) 300% stronger than conventional solutions	EN 1603	
Dimensional stability level under specified conditions – temperature 70 °C, 48 h	DS(70.-)2 - (≤2 %)	EN 1604	
Compressive stresses at 10% strain	CS(10)300 - (≥ 300 kPa) 250% higher strength than conventional solutions	EN 826	
Declared thermal conductivity λD	0.034 W/(mK)	EN 12667	
Compression behaviour during long-term compressive stresses 90 kPa (= 90 T/m ²)	2% relative creep deformation at compression 500% more! Izodom foundation slab withstands 9t/m ²	EN 13163	
Water absorption by immersion	WL(T)1 1 % Exceptionally low absorption!	EN 12087	
Water vapour diffusion coefficient	MU70	EN 13163	
Fire reaction class	EUROKLASS E	EN 11925-2	PN-EN 13501-:2007+A1:2009

acc. to Declaration of Performance No. 11/09/2014

The table presented above collects results obtained from testing elements of the foundation slab. The results conclude that the Izodom products are manufactured very carefully, they are exceptionally resistant to pressure, guarantee moisture protection and provide excellent cold protection.

What is needed to construct the slab

Soil investigation, depth determination at which the groundwater is located, linear and concentrated loads applied to the slab, building type and the land development plan with spatial location of the building on the plot.

When our elements of the foundation slab are ordered, we will cut them to the right size before shipment and attach a technical drawing to indicate the manner of professional installation.

Benefits: you build reliably, accurately, durably and save time, produce no waste on site and avoid thermal bridges.

How to construct the Izodom wall

The wall elements manufactured by Izodom make it possible to erect external, internal, partition walls as well as foundation footing and walls. Our company offers elements of various thicknesses of the thermal insulation layer ranging from 5 cm up to 30 cm. All elements have some space for concrete filling to construct concrete walls of two thicknesses of the load-bearing cores: 15 or 20 cm.

Advantages of the Izodom walls:

- 1 Five times faster construction compared to conventional methods,
- 2 The Izodom wall requires no thermal insulation,
- 3 Perfect insulation tightness- absolutely no thermal bridges,
- 4 Allergy-sufferer-friendly wall - resistant to moisture and fungi growth,
- 5 Durability lasting over 150 years,
- 6 Good sound insulation.

What you should know before commencing works

The construction is quick as the elements are light and easy to handle. 1 m² of wall usually consists of two basic elements – the weight is 4-9 kg/m², but the concrete poured inside weighs as much as 300 kg/m². Therefore, even up to 4 m² of durable and warm wall can be constructed within an hour!



For the construction, you will need a hammer, a level, a wood saw and caulking foam.

Depending on its weight, one element weighs from 1.8 to 4.8 kg. Each element yields as much as 0.5 m² of wall!

Construction stages of the Izodom walls

External walls

When you start construction with the Izodom elements, the first elements are placed on foundation walls or the foundation slab, on the prepared waterproof membrane, e.g. strip of film or membrane. Now, external walls are to be reproduced along the building outline, with the internal and division wall elements erected at the same time.



The first layer of elements.

In most cases it is not necessary to take out any reinforcement from the foundation. The elements are placed in such a way that they are staggered to avoid overlapping of element joints.

While joining thicker elements of external walls with internal walls or constructing corners using basic elements, cut out openings to join the concrete in both cavities.



When a portion of the element is removed, continuity of concrete filling will be obtained.

Once three layers of the elements are arranged, i.e. a wall which is 75 cm high is ready, the elements must be checked for levelling. Should it turn out that any of the wall sections is below the assumed level, it can be raised using wooden wedges mounted between the flooring and the first layer. If the expected level is exceeded, the lower teeth layer can be cut. When the walls are levelled, proceed with the installation of steel supports supplied by Izodom. The joint of the first layer with the base must be made with caulking foam.

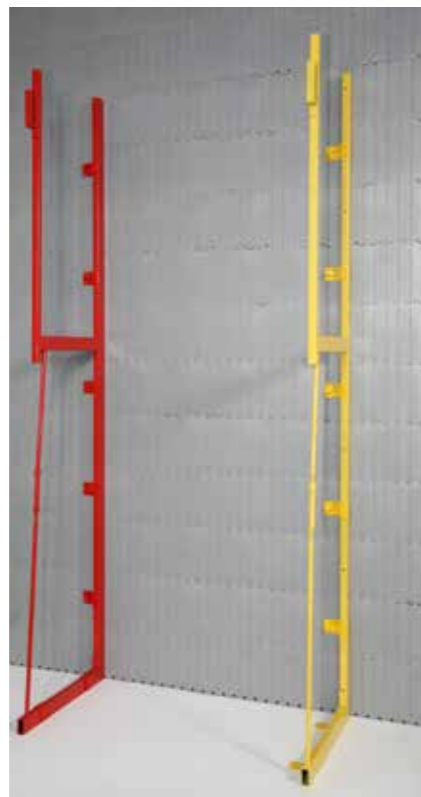

Steel supports make it easier to construct the wall, ensure plane control and maintain the vertical orientation. Red supports are suitable for installation of the 110 cm high extension element.

Once the first three layers are levelled, continue to construct the structure up to the storey height.



While constructing reveals and blunt wall endings, close up openings in the formwork with OH, OB and OC elements.

Internal load-bearing walls

The internal walls are usually constructed using elements available in the Standard System – MC 2/25 or MCFU 2/25. By cutting openings at the point where elements are joined, it will be possible to make a monolithic connection of both walls.

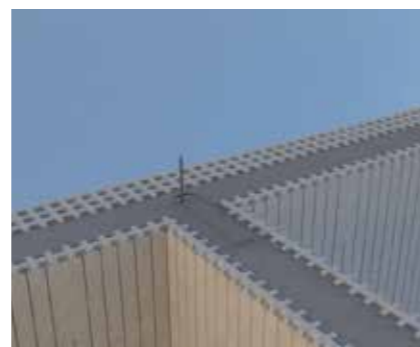

Partition walls

Partition walls can be constructed with MCF 1/15 elements or by conventional methods; just build the walls or install gypsum boards on the steel frame.



MCF 1/15 element at the corner.

Corners

The corners are constructed by means of special corner elements – they feature 90°, 45° and 135° angles. The photo shows MCFU 35 elements constituting an internal corner.



All corner elements are manufactured in two versions as left and right elements – one element portion is longer to connect it by overlapping with wall elements.



MCFU 35 corner elements (right and left versions).

The full range of corner units also includes the internal and external versions to construct external building corners and bays – located at wall internal angles, e.g. balconies, porches.

The MCF 0,7/25 hinge elements are used to shape corners at any angle.



The use of hinge elements to shape corners at any angle.

Headers

To make the work easier at the construction site and avoid thermal bridges in headers, our company offers a range of ML header elements.



The header element has a U-shaped cross-section.

The header element with two side walls and a bottom is used to place easily reinforcement of the header beam which, once concreted, becomes a structural component with monolithic connection to the walls. The external wall of the insulation element will provide appropriate thermal insulation.



Placement of reinforcement in the ML header element is simple.

Construction stages of the Izodom walls

Ring beam

The ring beam, where the floor meets with walls, is a very important building component. It can be constructed using the MP element.



The MP ring beam element has an external insulation layer, which is the same as in the entire wall.

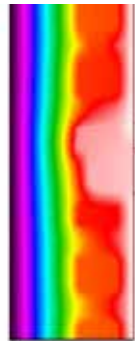

By using the ring beam element, continuity of thermal insulation is obtained and thermal bridges at the contact of the wall with the floor are avoided. Blue colour indicates the area of low temperature, which is kept distant from the building interior.



The MP element makes it possible to place reinforcement of the ring beam within the wall axis and floor support.



The MP element is perfect for insulating the wall plate. This element can be used to finish the knee wall by fixing the wall board to the concrete wall within the wall axis. Insulation of the MP element can be easily joined with roof insulation.

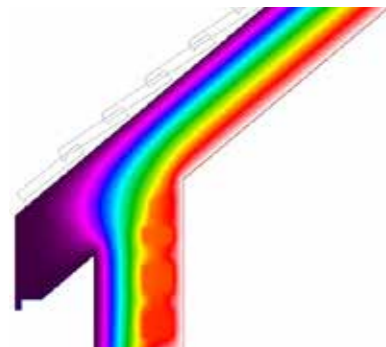

The illustration presents very good thermal protection ensured by the use of the MP element while constructing the knee wall. Continuity of the insulation layer protects the building from heat loss and moisture.

Water and sewage systems

Water and sewage risers can be arranged during erection of walls, before concreting. Horizontal branches are routed through side walls of the elements and sealed with caulking foam.



The water and sewage system can also be placed in the grooves in the floor internal wall (5 cm thick).



Electrical systems

Electrical systems are arranged along grooves. Prior to application of the finish material on the wall, the grooves can be filled with gypsum or caulking foam.



Stairs

Stairs are usually constructed in a traditional manner, as a cast-in-situ concrete structure or self-supporting wooden or steel structure.



Windows and doors

Door and window frames are mounted by attaching them to the wall concrete core using bolts of appropriate length. Gaps are filled with caulking foam.



If energy efficiency is required, the frames are mounted within the plane of the external insulation layer using the so-called "warm installation" according to recommendations provided by the joinery manufacturer.

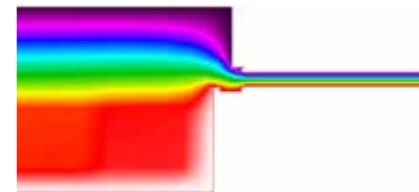

The illustration presents how good "warm installation" is to protect windows from cold intrusion.

Concreting

The Izodom elements are suitable for pumping concrete up to the height of 3 m – the entire height of a storey. Its unique strength is due to a special manufacturing process and high material density. Concrete weighs 2.5 t/m³, and a medium-sized house is equal to as many as 130 tonnes of the mix. The concrete mix can be cast manually, but it will be much quicker and efficient to use a pump for this purpose. Pumping concrete reduces the time necessary for concreting walls in one storey in a house occupying an area of 150 m² to 4-4.5 hours. Concrete must be poured by circular moves in layers of 0.8 to 1 m high. To make sure that there will be no bug holes in the concreted walls, aggregate with the maximum size up to Ø 8 mm must be used. For better concrete spread without adding more water, plasticisers can be used. Vibrators commonly applied in the construction industry must not be used. Concrete can be compacted by rodding or tapping of the concrete wall.



While pouring concrete with a pump at a speed of 6 - 9 m³, as many as 40 to 70 m² of walls can be filled in just one hour!

Construction stages of the Izodom walls

Internal finish work

Inside the house, plasters of the minimum thickness of 10 mm are most common; the plaster is applied directly on the wall (dedusted, primed and wiped with a notched trowel). An equally popular solution is to use 13 mm gypsum boards fixed with bolts or adhesive.



While applying gypsum plastering, corners are reinforced using profiles to provide them with better impact strength.

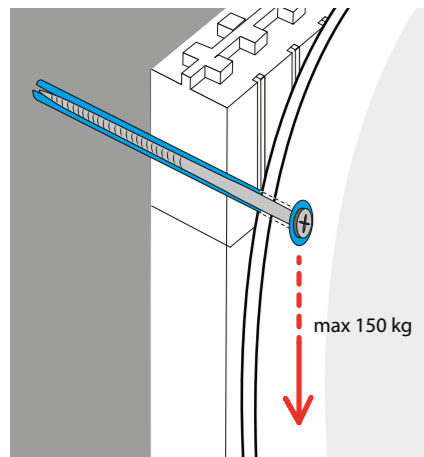

External finish work

Any finishing material can be applied on the external side: clinker, wood, siding, stone or thin-layer plaster using the adhesive-mesh-plaster arrangement.



In Scandinavian countries, a wooden facade mounted on frames, which are fixed with expansion bolts screwed into the insulation layer, is popular.



The most popular thin-layer plaster can be combined with other materials.



In the Netherlands, Belgium and Germany, the Izodom houses are finished with clinker.



The finish on an energy-saving Izodom house is really a matter of your choice.

Hanging

Light objects (paintings, clocks) up to 3 kg are hung by anchoring them in the plaster layer, whereas heavy objects are hung with expansion bolts by fixing them in the concrete core. One 15 cm long bolt anchored in the concrete to the depth of 10 cm has a load capacity of approx.

150 kg. This means that 4-6 bolts are sufficient to hang very heavy kitchen cabinetry, a boiler, etc. In order to maintain continuity of the insulation layer, the IZO FID 50 bolts (see page 25) are used to hang objects on the external building facade.

How to place the Izodom floor slab

The market offers many technologies designed to construct floor slabs. There are cast-in-situ concrete floor slabs, pre-cast floor slabs and multichannel wooden slabs. The TERRIVA beam and block flooring system has enjoyed much popularity. Izodom offers a floor slab system which makes it possible to construct beam and block floor slabs with the advantage of lighter filling elements since they are made of ESP.

The Izodom beam and block flooring system is very light. 1m² of such a floor slab amounts to only 180-200 kg, which corresponds to 30% of the weight of conventional cast-in-situ floor slabs, and therefore they are often applied in buildings with low load capacity walls. This solution is very durable, ensures high load capacity to be selected as per the needs. With typical reinforcement of ribs, the floor slab is capable of transferring loads up to 4 kN/m² (residential housing) to 16 kN/m² [1.6 ton/m²] (public access buildings, utility buildings). An essential advantage here is the thermal insulation characterised by 0.26 – 0.32 W/m²K. The Izodom floor slab products are also suitable for green, inverted roofs, slab roofs as well as terraces with residential parts.

For more information, please refer to Information Bulletin no. 3.



The reinforced concrete floor slab (6 cm thick) is supported on horizontal beams – ribs spaced at 75 cm. All structural components are permanently fixed on load-bearing walls. The graphic representation shows the situation with removed ESP elements to emphasize concrete structural components.

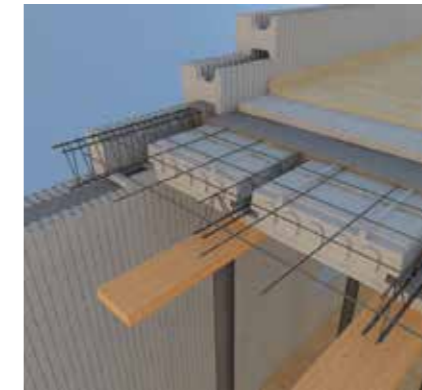

Concrete is poured onto floor slab shape units and the reinforcement. It fills hollow sections to shape structural reinforced concrete beams, with the load-bearing plate formed at the same time on the top. Cast-in-situ slabs are joined with walls within the plane of the ring beam to create a compact and durable structure.



Pre-cast reinforcement beams supplied by Izodom are placed between floor slab elements. Depending on the width of the Izodom room, beams of suitable length are selected; they can be as long as 7.8 m. Reinforcement of the floor slab is placed on the top of the elements. Reinforcement of ribs – beams is supported on the load-bearing walls.

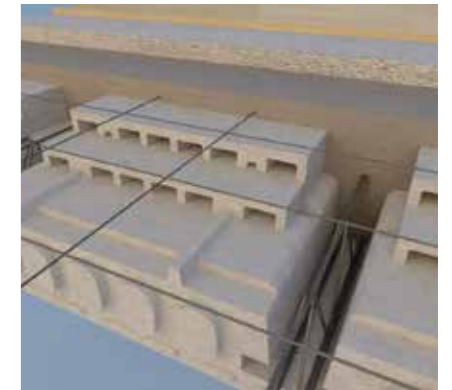

If a large span or heavily loaded slab is constructed, structural carrying capacity of the beam (rib) can be increased. By arranging additional STN 5 cm thick cover type floor elements on STP floor shape units, the resulting rib height is increased. The standard rib height is 20 cm, with one STN cover element – 25 cm, with two STN cover elements – 30 cm.

Placement of the Izodom floor slab

Support installation

Floor construction begins with installation of support and belt type formwork or shuttering boards on which floor shape units are to be placed.



Placement of slabs

The elements are placed next to one another, with the installation of rib reinforcement at the same time.



Slab reinforcement

Rib reinforcement is supplied with a sufficient length margin so that it can be supported on load-bearing walls within the ring beam plane. The picture also shows ring beam reinforcement and the relevant insulation (MP element).



Additional protection

Once concrete is cast, immersion vibrators can be used to avoid pocket forming. Then the leveling compound must be trowelled. The MP end elements will make it easier to place subsequent wall elements on the higher storey. System risers (shown in the picture) are to be inserted into the wall element cores.



Finish work

Finish the floor by analogy with walls. Apply gypsum plaster, gypsum boards or arrange the suspended ceiling.



List of available Information Bulletins issued by Izodom:

Issue No. 1: Basic information on material and erection technology offered by Izodom 2000 Polska

Issue No. 2: Design and calculation guidelines for walls of the Izodom 2000 Polska system

Issue No. 3: Floors of the Izodom 2000 Polska system

Issue No. 4: Halls, cold stores, warehouses of the Izodom 2000 Polska system

Issue No. 5: Design and calculation guidelines for sand concrete walls of the Izodom 2000 Polska

Issue No. 6: Design and calculation guidelines for swimming pools of the Izodom 2000 Polska system

Issue No. 7: Roofs of the Izodom 2000 Polska system

Rules of using thermal insulation on rafter and flat reinforced concrete roofs.

Issue No. 8: Foundations slabs of the Izodom 2000 Polska system

Issue No. 9: Application of the Izodom 2000 Polska wall system in regions of seismic risk

Issue No. 10: Ground temperature distribution following application of the Izodom slab foundation

Issue No. 11: Catalogue of linear thermal bridges for selected structural details of the Izodom system

Issue No. 12: Thermal conductivity of space dividers in the Izodom technology Foundation, walls and roofs

How to place the Izodom roof slab

The large-size insulating roof slab (above the rafter) is used to install tight wooden roof insulation with the rafter structure.

Another use of the slab is to insulate flat roofs and slab roofs of reinforced concrete structure.

Advantages of the Izodom roof slab

- 1 Perfect thermal insulation without undesirable leakage $U_o=0.15-0.11 \text{ W/m}^2\text{K}$, as standard for the passive house, reduced heat loss through the roof,
- 2 Excellent building protection against moisture,
- 3 Quick and easy installation.



Schematic joint of the Izodom roof slab with the wall.

Types of the Izodom roof slabs and their characteristics

There are two types of roof slabs:

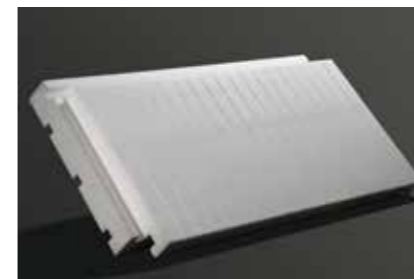

DPL – GLT slab (dimensions 190x90x22/25 cm) – used under flat covering, including trapezoidal metal sheet, corrugated metal sheet and panels as well as membrane covering.

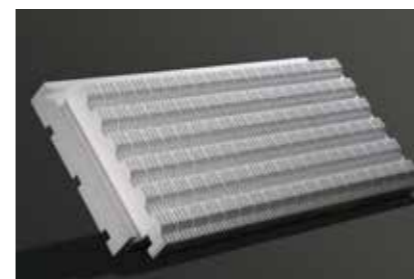

DPL – ZIG slab (dimensions 190x90x22/25 cm) – used under covering consisting of plain tiles.

Both types of slabs are provided with perimeter hook locks, which join adjacent slabs into monolithic thermal insulation to avoid thermal bridges in the contact zone of conventional ESP slabs commonly used in the construction industry.

In addition, the slabs have 10 mm wide channels spaced at 100 mm. The channels discharge condensate and water on the surface from any leakage in the installed roof covering.

The design of these channels allows water discharge from the roof planes, the slope of which exceeds 11 degrees. If it is required to increase thickness of the roof insulation, common ESP slabs can be used to fill in the spaces between roof rafters.



The DPL - ZIG slab is designed for perfect protection of the roof and easy installation of plain tiles.

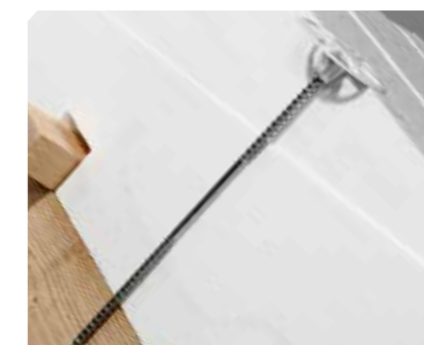

Expansion bolt used to fix the Izodom roof slab.

How to place the Izodom facade panels

The wide offer of Izodom includes special thermal insulation panels for any type of construction for easy and efficient insulation of the building. The vented insulation panels and panels with grout present a perfect solution for the existing buildings requiring thermal insulation.

IZOALFA panels with grout

Insulation panels with grout are suitable for easy finishing of the facade with 71 mm high clinker tiles. Comfortable and simple installation of the tiles is possible due to the special profile of the external panel surface fitted with parallel several millimetre horizontal "strips". Applied clinker tiles are finished with epoxy grout providing both elegant and very durable building facade.

The panels are joined using tongue and groove connectors around the perimeter. This type of connection between the panels prevents thermal bridges and provides a smooth and tight surface of the installed insulation.

Advantages of thermal insulation panels:

- 1 Excellent insulation performance,
- 2 Non-absorptive surface,
- 3 Repeatable dimensions and angles,
- 4 No thermal bridges,
- 5 Perimeter "tongue and groove" locks,
- 6 Quick installation,
- 7 Durability and simple installation.

IZOBETA vented panels

The vented panel is designed for thermal renovation of buildings. With the use of innovative solutions developed by Izodom, application of this panel type provides two effects: thermal insulation of the existing buildings and permanent drying of the insulated wall. As a result of migrating water vapour from the wall, running through internal vertical and horizontal channels, it is finally evacuated into the atmosphere through the installed mini ventilation grilles.

The panel is installed in a conventional manner using adhesive and plastic collar expansion bolts. The bolts fix the panel by means of a special collar in the upper and right edge of the panel. This collar is covered by another panel mounting, which makes it possible to avoid thermal bridges. Insulation consisting of the IZOBETA panels can be finished with thin-layer plaster or facade tiles.



The IZOALFA panel means easy insulation of the building and aesthetic finishing.

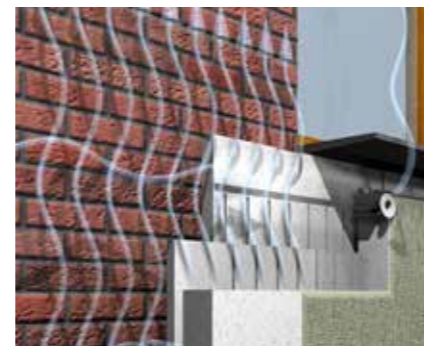

The IZOBETA panel insulates and dries building walls.

Our offer includes panels made of conventional white ESP and grey Neopor. These raw materials are manufactured by BASF. They are characterised by a low heat-transfer coefficient and are resistant to microbial corrosion.

Placement of the IZOALFA panel



Installation conditions

Thermal insulation work must be performed at a temperature ranging from 5 to 25 °C on dry days. Do not start the work on walls exposed to intense sunlight or if rapid temperature drops below 0 °C occur as this may cause facade damage at a later time. For the thermal insulation, any flat load-bearing substrate featuring appropriate strength and surface evenness can be used. The substrate must be cleaned from dirt, in particular dust, fat and any other anti-adhesion substances. It is recommended to have the substrate cleaned with water under pressure in advance.

Substrate inspection

Once cleaned, the substrate must be tested for its strength. This test must be carried out by the insulation designer using suitable equipment.

Panel preparation

Prior to installation, the panels must be seasoned. They must not be exposed to weather conditions for longer than 7 days; semi-yellowed surfaces must be ground off and dedusted.

Panel installation

Always start and finish panel arrangement evenly with the edge of the wall being insulated. They must be attached to the substrate with the staggered configuration of vertical joints ensured; tongues and grooves must mate on the panel periphery. Panel joints cannot be crossed or located on wall cracks. When arranged, the panels must cling to one another. No adhesive compound can be left in the joints. Panel parts protruding from the wall edges must be cut off. When continuing with the insulation of another wall, install the panels in such a way that they overlap with the insulation installed on the previous wall.

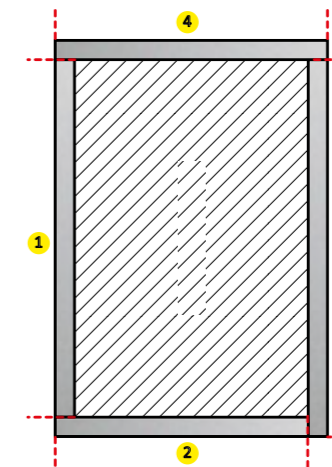

Adhesive-applied wall insulation is arranged with lapping joints.

Application of adhesive compound

Apply adhesive compound on the rear surface of the panel along strips and points. The amount and thickness depends on the substrate condition; however, good contact with the wall must be ensured. Once covered with the adhesive compound, put the panel on the

wall and press it down. Do not press again or displace the panel once it has been applied.

Insulation sealing

The surface of the applied panels should be even, and the gaps between the panels must not exceed 2 mm. Any surface unevenness must be smoothed using abrasive paper.

Mechanical fixture

In some cases it is recommended to provide additional mechanical fixture using connectors. The type, length and quantity of connectors is to be determined by the designer.

Wall finishing

Wall insulation is finished by applying clinker tiles between existing "strips" on the insulation panel. Once the adhesive is cured, the gaps between the panels are filled with some epoxy grout.

Each type of the panel is made in an individual mould. Thus, geometry of the panels and the perfect smoothness of all surfaces ensure excellent joining of adjacent panels and no gaps. Also, the obtained insulation plane is exceptionally even. There is no need to grind the external insulation surface.

Placement of the IZOBETA panel



Panel preparation

Attach the start strip for the 8 cm or 12 cm thick panels, depending on the chosen insulation thickness. For panels to be installed in the first bottom row of the insulation, the lower tongue must be removed.

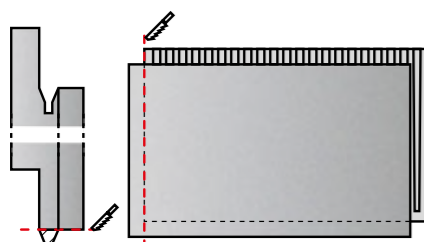

Beginning of the installation

Start installation of the first panel row by cutting the left protruding side of the first panel. Apply the panel with adhesive and fixed it using 3-4 expansion bolts attached to the collar of the upper and right side of the panel. Arrange the panels beginning on the right side in each subsequent insulation row.

Panel installation

For insulation of the building surface, follow the following rule: while insulating the first panel, start and end attaching the panels evenly re-

lative to the left and right edge. Shift each subsequent panel row relative to the previous one by approx. 1/2 of the panel length. While insulating a subsequent wall, attach the first panel of the lower row so that the left side can overlap onto the already installed installation. All panels of any subsequent row of panels must be cut to fit the right edge of the wall.

Insulation sealing

Prior to finishing the facade, all visible ducts on the corners, window and door openings must be blanked off using low pressure foam to the depth equal to the thickness of the installed thermal insulation.

Water vapour discharge system

In order to evacuate excessive water vapour from walls in one-storey buildings into the atmosphere, a baffle made of 6 cm wide foil strips should be placed between the last but one and the last row of the arranged slabs. The foil closes vertical gaps and prevents water vapour from migrating upwards inside the ventilation panel. Water vapour will accumulate in the upper internal horizontal duct below the foil barrier. The accumulated vapour is discharged through the IZO BEL vent tubes supplied by Izodom. Such foil barriers must be also installed under windows openings to prevent water vapour from penetration into the space under the window sill. The tubes should be glued in the openings located 35 mm

below the upper external edge of the panel spaced at 1.5 to 3 m. The tubes must be installed when the fibre glass mesh is being glued. For this purpose, you need:

- a) drill a hole in the external layer of the gap panel,
- b) cut up the mesh at the drilled hole,
- c) continue to work according to the technology of thin-layer plastering,
- d) glue in the vent tubes at the marked places.

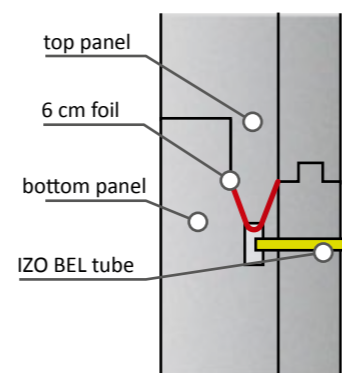

Subsequent storeys

For multi-storey buildings, foil baffles must be the same as in the one-storey buildings. The baffles must be located at the grade of each storey.

Partner companies of Izodom:

To those who construct together with Izodom, we recommend products offered by our proven companies, distinguished by the Ministry of the Environment under the GreenEvo project:

Recuperators



NIKOL Jan Nikolajuk
15-509 Białystok
Sobolewo, ul. Sobolewska 5
Tel.: (85) 676-10-72
e-mail:
biuro@rekuperatory-nikol.pl
www.rekuperatory-nikol.pl

Building heating systems



„MAKROTERM”
31-354 Cracow
ul. Pasternik 76
Tel.: (12) 379-37-90
e-mail:
makroterm@makroterm.pl
www.makroterm.pl

Private onsite waste-water treatment systems

(10% discount if you mention the keyword “Izodom”)



AQUATECH
00-019 Warsaw
ul. Złota 7 lok. 18
Tel.: 510-255-900
e-mail: info@oczyszczalnie.org
www.oczyszczalnie.org

Environmentally friendly pellet-fired heating boilers



FU - WI
82-300 Elbląg
ul. Grochowska 5B
Tel.: (55) 232-65-38
e-mail: info@fuwi.pl
www.fuwi.pl

Our company is a member and co-founder of two clusters:

- Cluster of Knowledge and Innovation Community in Production Engineering www.klaster.ptzp.org.pl
- Lodz Cluster of Building Innovations



DOWNLOAD E-CATALOGUE
http://www.download.izodom.pl/product_catalogue.pdf

Step 1:

Find out more about the technology offered by Izodom.

Step 2:

Select the system you want to use to construct walls of your house.
Select the foundation and roof slabs to go with the walls.

Step 3:

Have you already obtained a house design?
Request a free of charge quotation of the materials necessary to construct your house.

Still no house design?

Request our House Design Catalogue:

klient@izodom.pl

Are you an architect?

Request a set of Information Bulletins.

architekt@izodom.pl

Find out how to arrange walls, the foundation and roof slabs.

Become a partner of Izodom!

partnerstwo@izodom.pl

Additional services

If you make a decision to construct your house in the Izodom technology, you can benefit from:

Transport

Owing to appropriate arrangement of elements for the construction of a medium-sized house (i.e. 150 m²) it is possible to dispatch all wall and floor elements in just one truck.

For larger orders, if requested by the customer, our company delivers the materials to the site in Poland for a token charge to cover the fuel cost.

Shipment

For foreign customers, Izodom can arrange transport to any location in Europe and worldwide.

Construction team

In Poland, our company has at its disposal a team of contractors executing constructions according to the technology. Outside Poland, our company has partners who can professionally perform the construction.

Design assistance

Izodom cooperates with architectural studios throughout Poland; they can develop complete documentation and the design of your house following the investor's idea.

Do you already use services of your architect or construction team?

Take part in the training!

Izodom offers training sessions on the premises of the company or its representatives to construction firms, architectural studios and design engineers. If necessary, our company can provide on-site training in Poland and abroad.

Completed projects - residential housing





izodom 2000 polska

IZODOM 2000 Polska Sp. z o.o.

ul. Ceramiczna 2a
98-220 Zduńska Wola

Customer service:

0048 – 43 – 823 – 41 – 88

0048 – 43 – 823 – 89 – 47

e-mail: klient@izodom.pl

Main office/fax:

0048 – 43 – 823 – 23 – 68

e-mail: biuro@izodom.pl

www.izodom.pl

www.pasywnedomy.eu

GPS: N 51°35'37.75"
E 18°58'28.55"

